

TOFORD AQUACULTURE

INTRODUCTION



Company Profile

- Established in 1978 as a PVC hose & PE pipe manufacturer
- 11,000 square meter (2.72 acre) facility in Pingtung, Taiwan
- Global clients across Asia-Pacific, the Middle East, Africa, Europe, and the Americas
- Quality Assurance
 - ISO9002 in 1997
 - ISO9001 in 2003
 - CNS in 1996
- Building on its manufacturing expertise in PE pipes, Toford expanded its service into cage fabrication and construction in 1995.
- More than 600 cages put into operation worldwide



Content

- Grid Sketch
- Grid Mooring Estimation Drawing
- Predator-Proof Cage with Extra-Wide Stanchion
- Traditional Double Collar Stanchion Cage
- **2014 NEW** Big-Small Double Collar Stanchion Cage
- Blue Ocean System Farm
- Walkway Path
- Recirculation Aquaculture System
- Nets & Automatic Net Washer Machine
- Equipment of Mooring System
- Raft Boat & Work Boat
- Water Light & Signal Light
- Dead Fish Collector System
- Easyfloat
- Deployed Cages

Grid Sketch

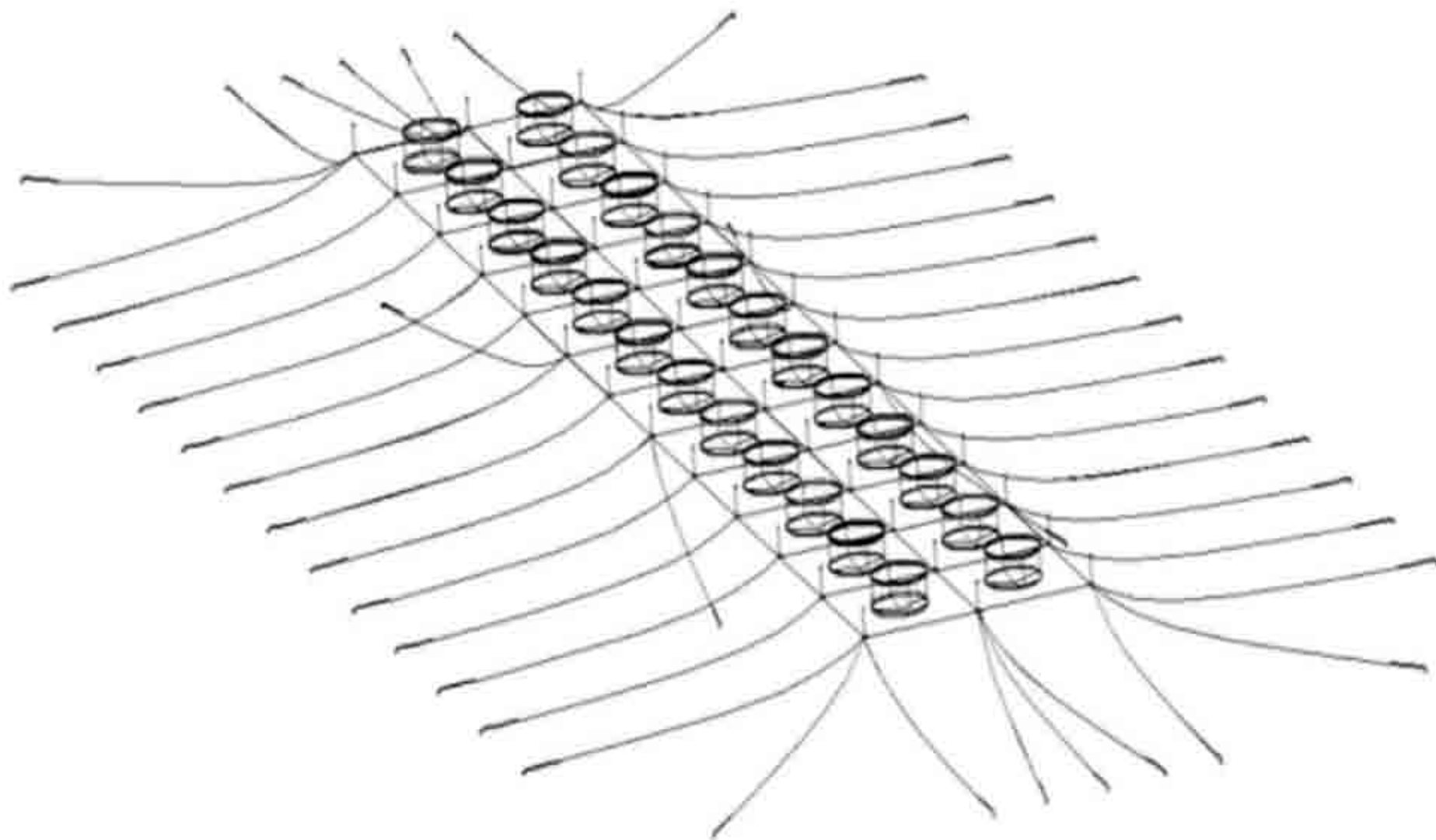

Grid Mooring Estimation Drawing

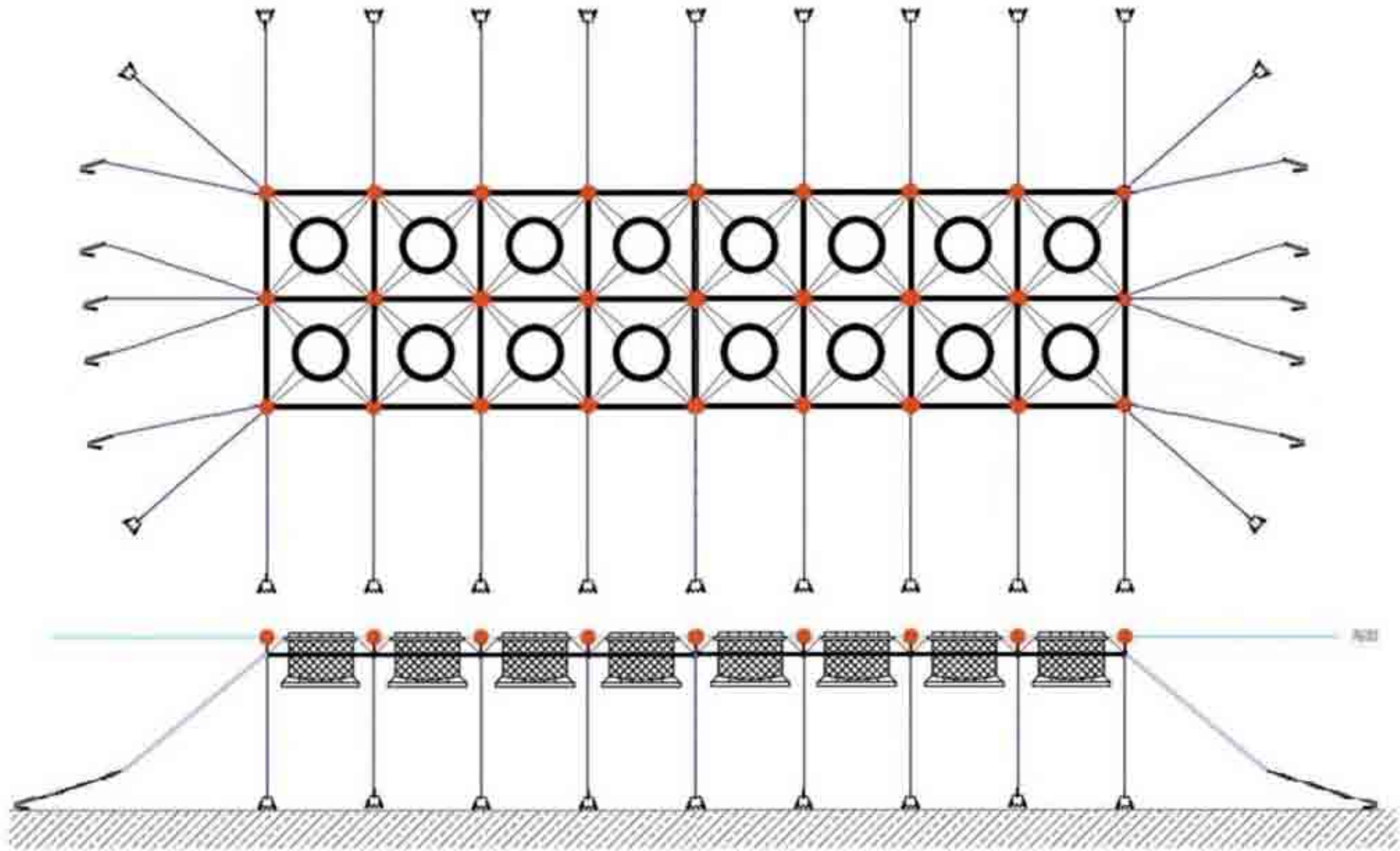

with Extra-Wide Stanchion

TOFORD Bevattningsteknik AB, Scandinavian
(Design & Fabrication)
Hoff Fuchia Cheng
Contact: Patric Torle
torle.bevattningsteknik.se

Representative:

Predator-Proof Extra-Wide Cage

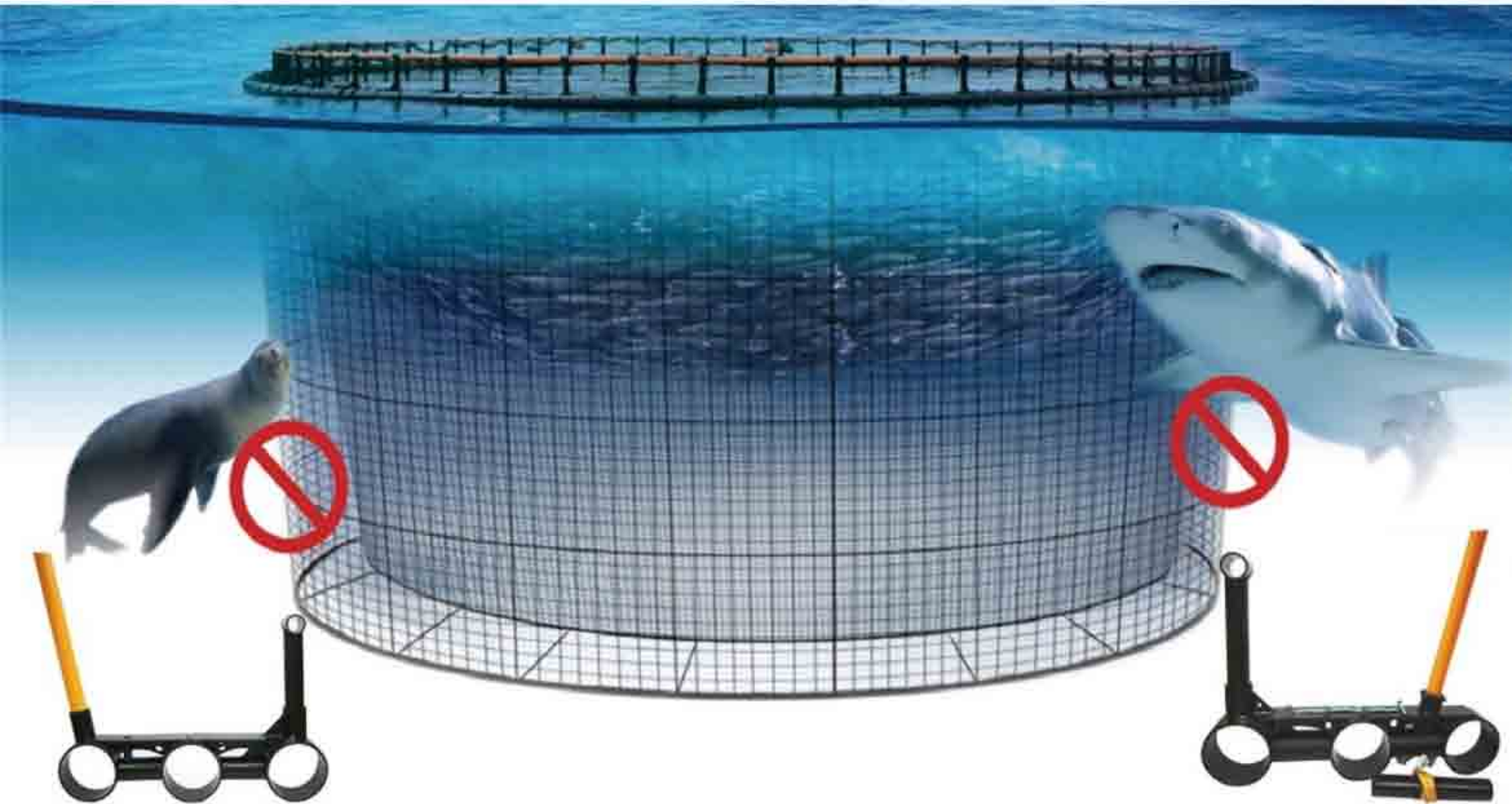

Predator-Proof Triple Collar Cage

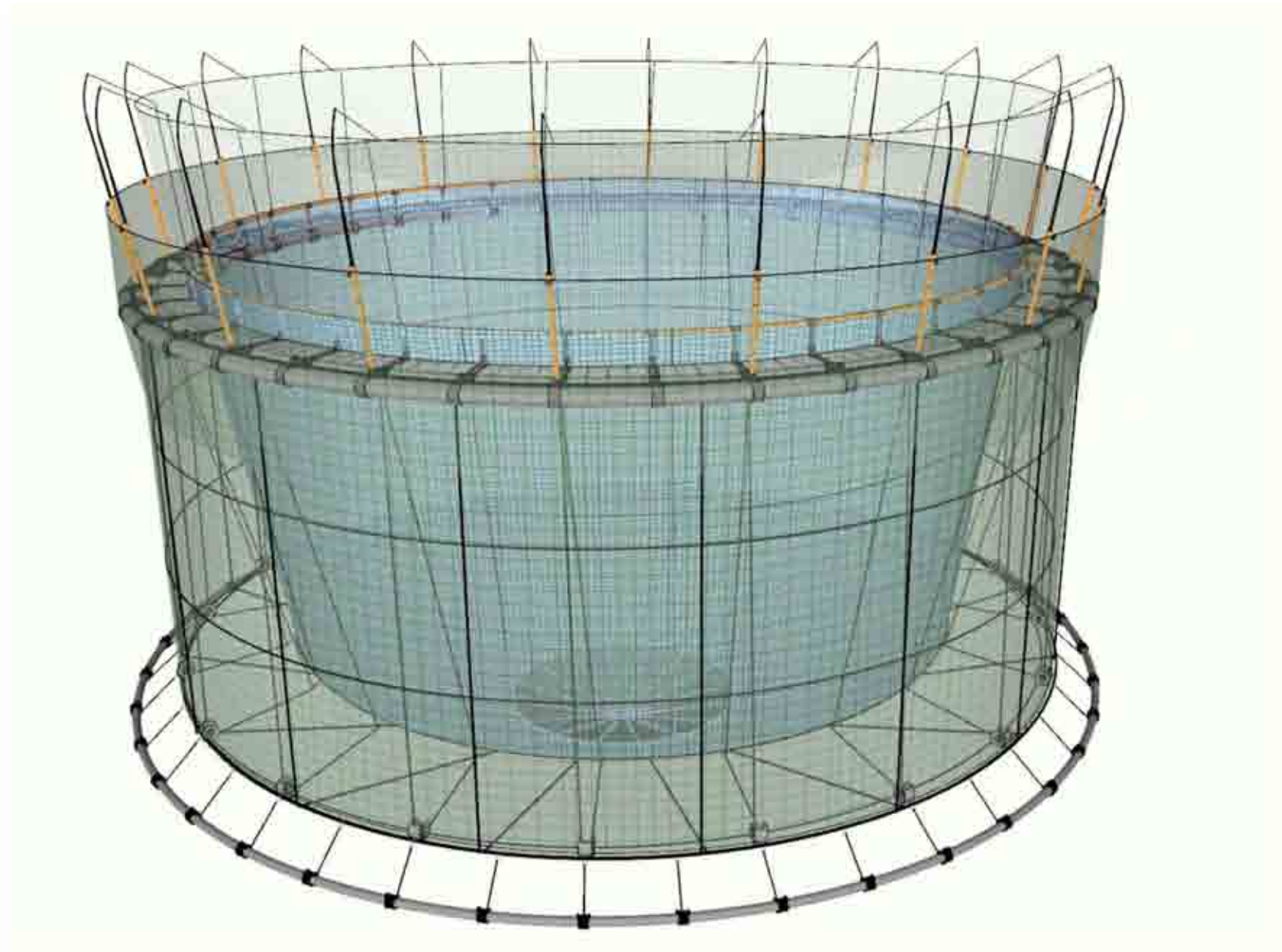

Predator-Proof Stanchion With Outer Seal Fence Pole

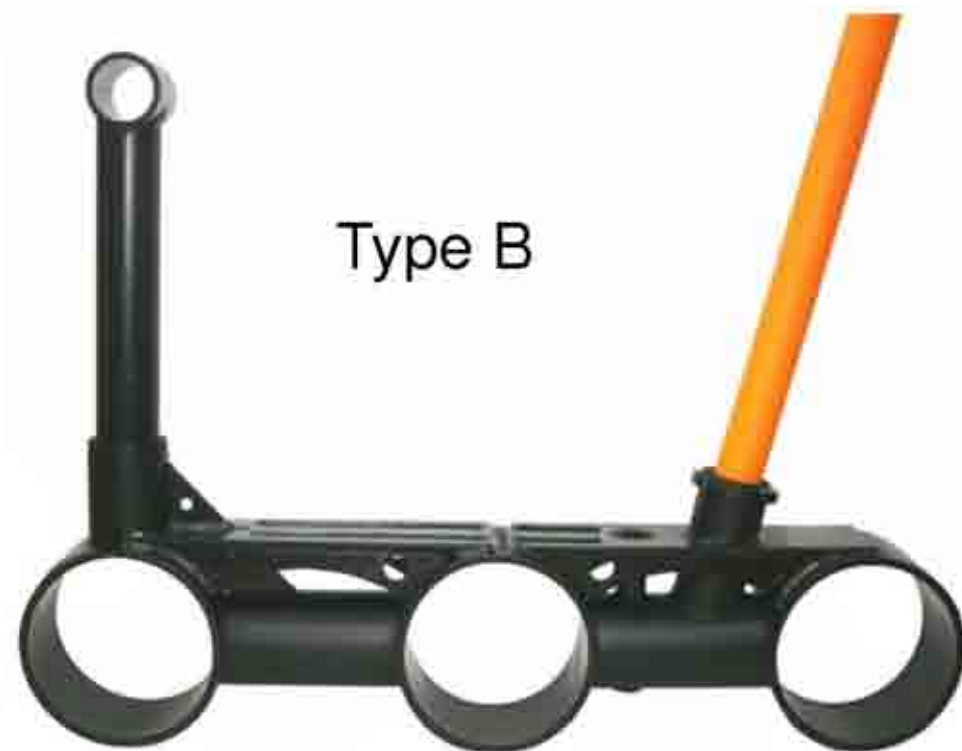
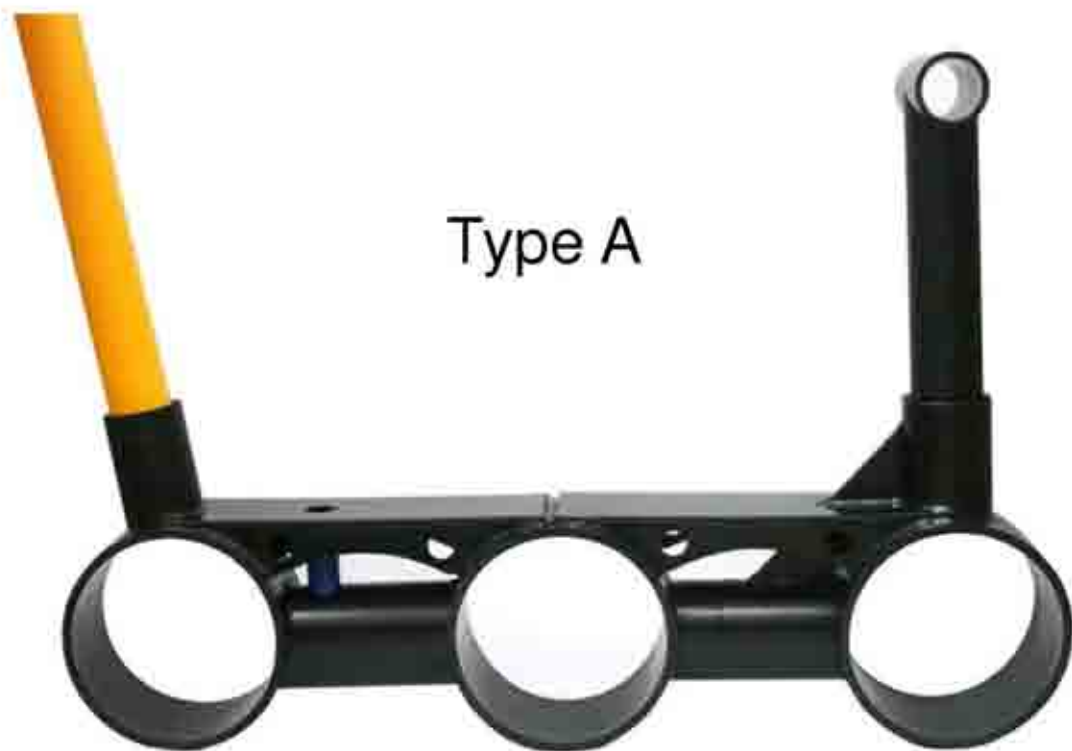

Predator-Proof Triple Collar Cage Models

- Superior expert fusion technique & PE-100 material for extra wide spacing stanchion
- Professional design for durability, factory fabricated stanchions

Cage Model	FY-315T	FY-355T	FY-400T	FY-450T	FY-500T	FY-560T
Floating pipe diameter	315mm	355mm	400mm	450mm	500mm	560mm
Standard circumference	75-110M	90-130M	110-160M	150-190M	180-240M	230-310M
Standard diameter	25 - 35M	30 - 40M	35 - 50M	45 - 60M	55 - 75M	75 - 100M
Stanchion spacing	205cm	215cm	228cm	238cm	266cm	283cm
Stanchion no.	44	56	48	68	80	112
Handrail pipe	110mm	110mm	125mm	140mm	140mm	140mm
Stanchion upright pipe	125mm	125mm	160mm	160mm	160mm	160mm
Mooring brackets	12 Pcs	12 Pcs	12 Pcs	16 Pcs	16Pcs	20 Pcs
Sinker tube available	250mm	315mm	355mm	400mm	450mm	500mm
Walkway decking available	Yes	Yes	Yes	Yes	Yes	Yes

All models meet NS 9415 / Factory is ISO 9001 certified / Customization is available

Double-Collar Stanchion Cage

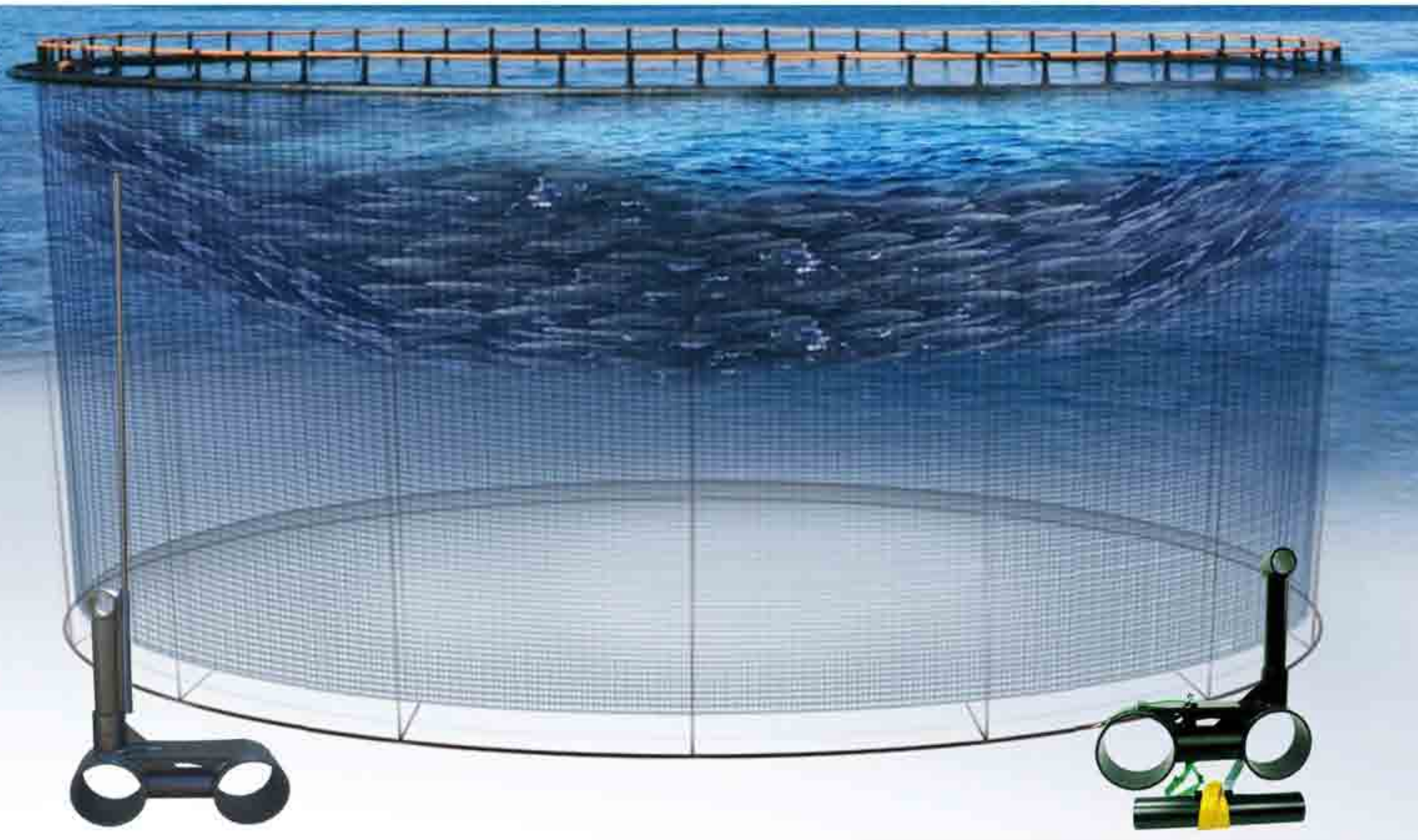

Double-Collar Stanchion



Separate Upright



One Piece

Double-Collar Stanchion Cage Models

- Superior expert fusion technique & PE-100 material
- Professional design for durability, factory fabricated stanchions

Cage Model	FY-225D	FY-250D	FY-315D	FY-355D	FY-400D	FY-450D	FY-500D	FY-560D
Floating pipe diameter	225mm	250mm	315mm	355mm	400mm	450mm	500mm	560mm
Standard circumference	30-50M	40-70M	70-90M	90-120M	110-140M	140-180M	160-210M	190-250M
Standard diameter	10-16M	13 - 22M	20 - 30M	30 - 38M	35 - 45M	45 - 56M	50 - 66M	60 - 80M
Stanchion no.	24	28	48	56	48	64	80	96
Handrail pipe	110mm	110mm	110mm	110mm	125mm	140mm	140mm	140mm
Stanchion upright pipe	125mm	125mm	125mm	125mm	160mm	160mm	160mm	160mm
Mooring brackets	8 pcs	8 pcs	12 pcs	12 pcs	12 pcs	16 pcs	16 pcs	20 pcs
Stanchion separation	2M	2M	2M	2M	2.5M	2.5M	2.5M	2.5M
Polystyrene added	Yes	Yes	Yes	Yes	Yes	Yes	Yes	Yes
Sinker tube available	200mm	200mm	250mm	315mm	355mm	400mm	450mm	450mm
Walkway decking available	No	Yes	Yes	Yes	Yes	Yes	Yes	Yes

All models meet NS 9415 / Factory is ISO 9001 certified / Customization is available e.g. 450-400, 400-355, 355-315.

2014 NEW

Balanced Stanchion Cage

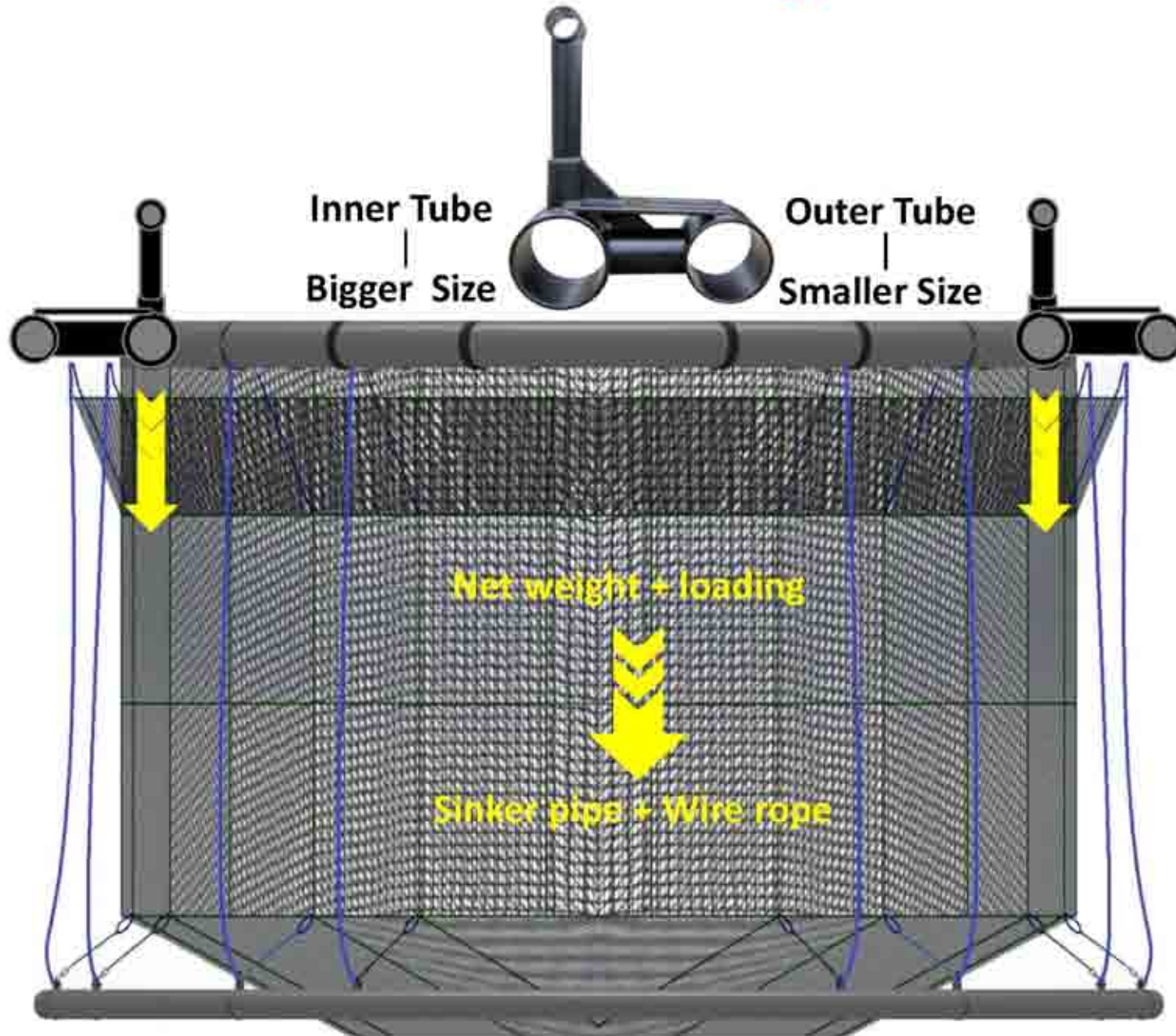

2014 NEW

Balanced Stanchion Cage

Technical Specifications – Circular Cages

Cage Model	FY-315/250D	FY-355/315D	FY-400/355D	FY-450/400D	FY-500/450D	FY-560/500D
Inner floating pipe diameter	315mm	355mm	400mm	450mm	500mm	560mm
Outer floating pipe diameter	250mm	315mm	355mm	400mm	450mm	500mm
Standard circumferences	50- 80M	80- 110M	100-125M	120-140M	140-175M	170-205M
Standard diameters	16 - 25M	25 - 35M	32 - 40M	38 - 45M	45 - 55M	54 - 65M
Stanchion no.	40	56	60	68	68	80
Handrail pipe	110mm	110mm	125mm	140mm	140mm	140mm
Stanchion upright pipe	125mm	125mm	160mm	160mm	160mm	160mm
Stanchion separation	2M	2M	2M	2M	2.5M	2.5M
Mooring bracket	8 pcs	12 pcs	12 pcs	12 pcs	16 pcs	16 pcs
PS safety floatation added	yes	yes	yes	yes	yes	yes
Net hooks (Stainless Steel)	8 mm	8 mm	8 mm	12mm	12mm	15mm
Available with sinker tube	200mm	250mm	315mm	355mm	400mm	450mm
Walkway decking available	yes	yes	yes	yes	yes	yes

*All models meet NS 9415

*Our factory is ISO 9001 Certified

*Custom made items available

One Piece Double Wall-Butt Fusion Stanchion



Blue Ocean System Farm

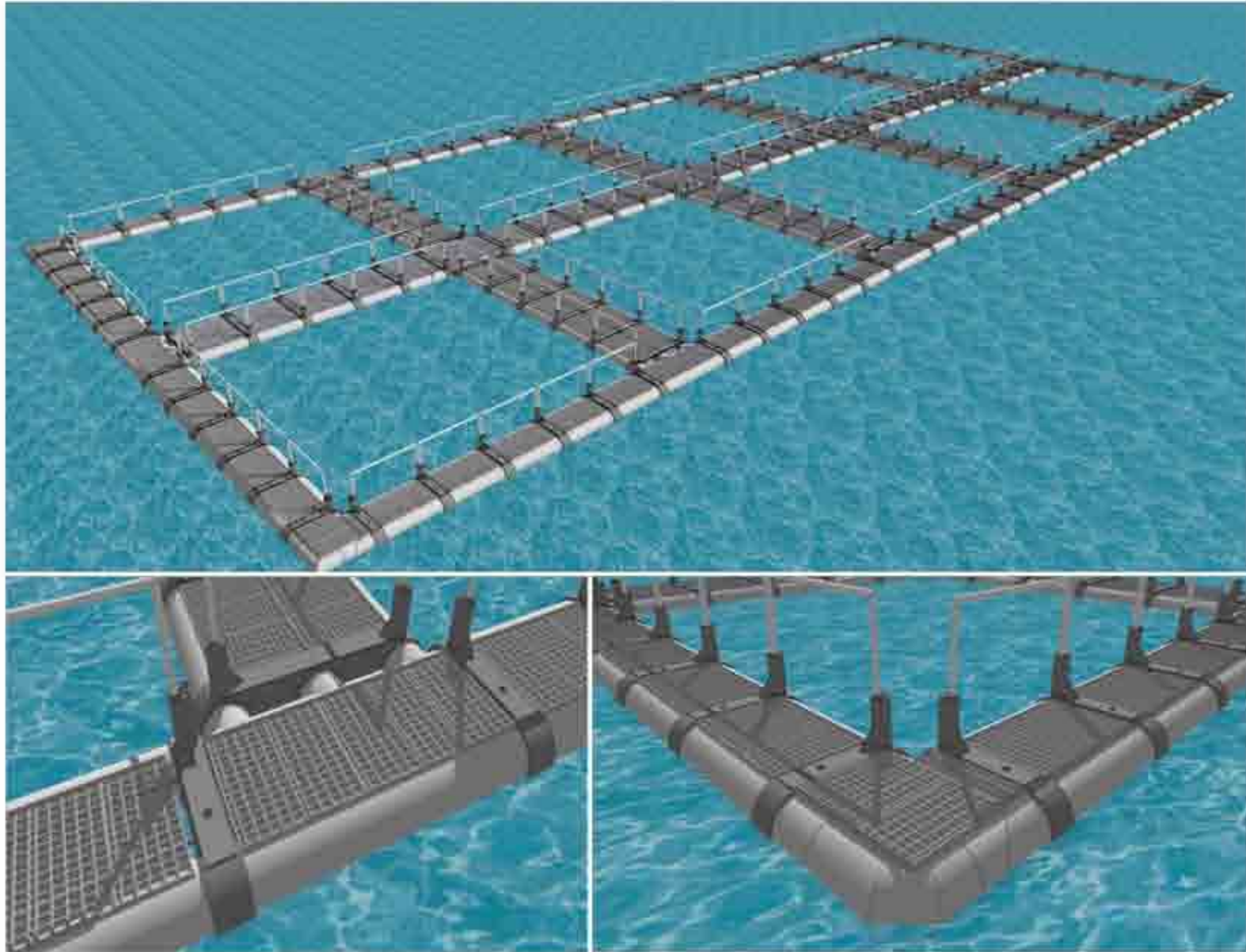

Blue Ocean System Farm Models

- Superior expert fusion technique & PE-100 material
- Professional design for durability, factory fabricated stanchion

Cage Model	FY-315BOS	FY-355BOS	FY-400BOS	FY-450BOS	FY-500BOS
Floating pipe diameter	315mm	355mm	400mm	450mm	500mm
Cage sizes-- Inner measurements	5 x 5 m 7 x 7 m 9 x 9 m 11 x 11 m	9 x 9 m 11 x 11 m 13 x 13 m 15 x 15 m	11 x 11 m 13 x 13 m 15 x 15 m 17 x 17 m	17 x 17 m 19 x 19 m 21 x 21 m 23 x 23 m	21 x 21 m 23 x 23 m 27 x 27 m 31 x 31 m
Centre aisle width	2.0M	2.0M	2.2 M	2.2 M	2.5 M
Centre aisle stanchion	Triple collar stanchion	Triple collar stanchion	Triple collar stanchion	Triple collar stanchion	Triple collar stanchion
Perimeter aisle width	0.9 / 1.6 M	0.9 / 1.6 M	1.3 / 2.2 M	1.6 / 2.2 M	1.6 / 2.5 M
Perimeter aisle stanchion	Double / Triple Collar stanchion	Double / Triple Collar stanchion	Double / Triple Collar stanchion	Double / Triple Collar stanchion	Double / Triple Collar stanchion
Distance between brackets	2.0 M	2.0 M	2.2 M	2.5 M	2.5M
PS Safety floatation added	Yes	Yes	Yes	Yes	Yes
Walkway decking available	Yes	Yes	Yes	Yes	Yes
Inner net depth	4 - 8 M	5 - 10 M	7 - 12 M	8- 15 M	10 - 20 M

*Different width is available

*Our factory is certified to ISO 9001

*Single square cage design is available

*Custom design and build available

Fish Cage Accessories



Circular Fish Cage



Square Fish Cage



Mooring Bracket



Bird net pole + Socket

RDM & SDM max length : 4.9 M

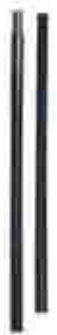

Walkway



Buoy



Bird net support



Sinker Ring Straps & Walkway Decking



Walkway Path

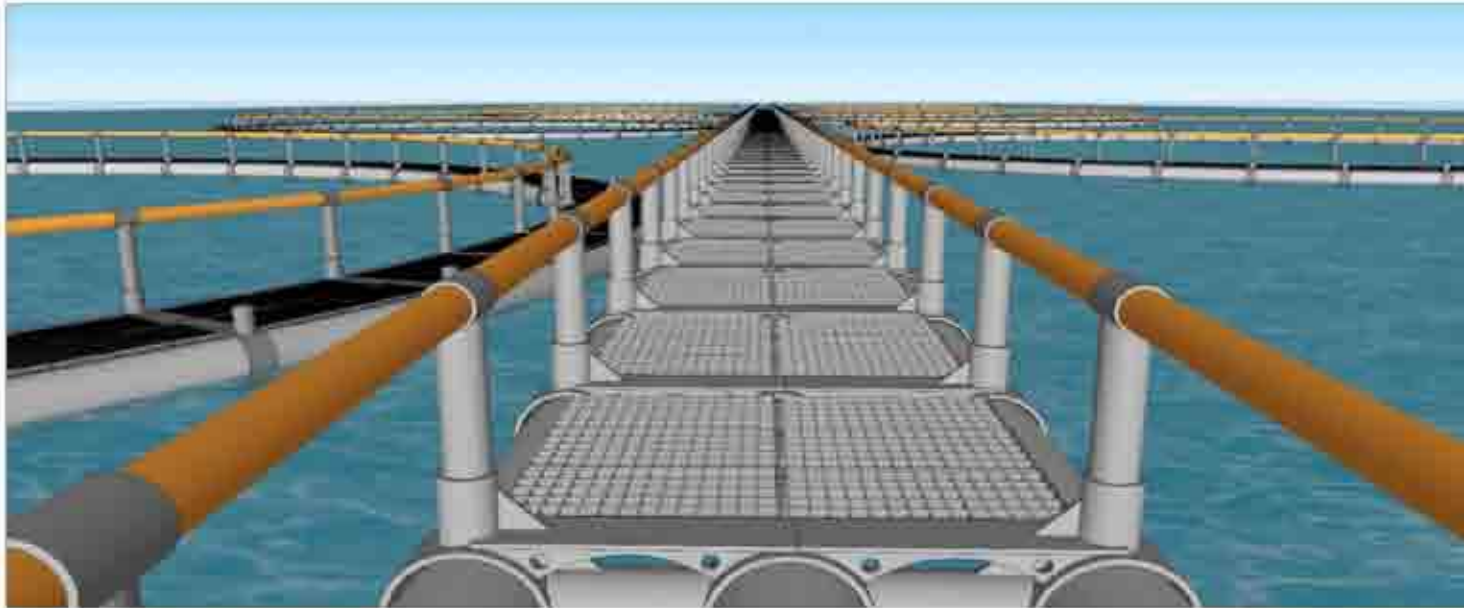

Stanchion Model	WKS-315T	WKS-450T
Floating Pipe diameter	315mm	450mm
Width of walkway	1300mm	1900mm
Handrail HDPE Pipe	110mm	140mm
Walkway Decking	Yes	Yes
Distance between Brackets	2M	2.5 M

Nets



Material	Density (g/cm ³)	Breaking Strength
PE	0.96	6 g/D
Polyester	1.38	9 g/D
Nylon	1.13	9 g/D
Dyneema	0.96	32-40 g/D
Ultra High Strength PE	0.96	32-40 g/D

Automatic Net Washer Machine

Toford supplies automatic net washer machine for washing of net.

The benefits you get from using automatic net washer machine are many, such as:

- Fast, simple and efficient removal feed leftovers and impure organic particle.
- Reduction of the spreading of diseases due to parasites, bacteria and viruses
- Creates healthier environment in the cages
- Improvement of dissolved oxygen concentration
- Final production increase
- Prolonged lifespan of fish farming sites



Recirculation Aquaculture Systems

Simplified Process Flow Chart for RAS

①

Fish Tank

These are the large culture tanks where fish are raised.

Recirculated Water
"In"

④

Dissolved Gas Control

Pure oxygen is injected to the returning water. Carbon dioxide is also removed.

Fish wastes &
uneaten feed



Recirculated Water
"Out"

②

Solids Removal

Solids, such as fecal material and uneaten feeds are removed by mechanical filtration.

③

Biofiltration

(Ammonia Removal)

Beneficial bacteria consume ammonia, which converted into nitrogen, is released harmlessly into the atmosphere.

Equipment of Mooring System

Anchor

Anchor Weight KGS	Holding Power in Tonnes		
	Sand	Medium Clay	Mud
250	30.89	23.92	17.27
375	42.64	33.01	23.84
500	53.60	41.50	29.97
750	73.99	57.28	41.37
1000	93.00	72.00	52.00



Chain

Size(mm)	Proof load KN	Breaking load KN
26	124	250
28	144	290
30	165	333
32	188	378
36	212	379
38	265	534
42	324	652
44	356	716
46	389	782



Buoys

Item no.	Article(FT)	Buoyancy (KG)
BB20	1.2	20.0
BB100	1.5	100
BB1000		1000



Thimbles

Size(in)	A1(mm)	A2(mm)	L1(mm)	L2(mm)	B(mm)	S(mm)
1-3/4	8	19	45	31	11	2.0
2	9	22	50	37	13	2.0
2-1/2	11	27	65	48	15	2.5
3	16	32	79	57	19	3.0
3-1/2	18	40	90	65	20	3.0
4	20	44	102	74	23	4.0
4-1/2	22	52	115	84	27	4.0
5	24	56	125	96	28	5.0
6	28	65	150	115	32	6.0
7	30	76	170	135	36	6.0
8	34	88	200	160	41	6.0

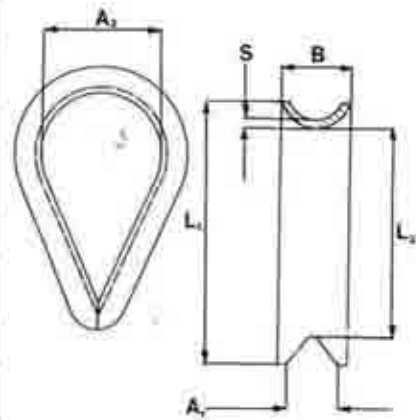

Shackles

Size(in)	SWL(5:1)	A(mm)	B(mm)	C(mm)	D(mm)	E(mm)	F(mm)
3/4	4.75t	19	22	31	76	51	112
7/8	6.50t	22	25	36	83	58	127
1	8.50t	25	28	43	95	68	147
1-1/8	9.50t	28	32	47	108	75	165
1-1/4	12.0t	32	35	51	115	83	178
1-3/8	13.5t	35	38	57	133	92	164
1-1/2	17.0t	38	42	60	146	99	202
1-3/4	25.0t	45	50	74	178	126	243
2	35.0t	50	57	83	197	146	269

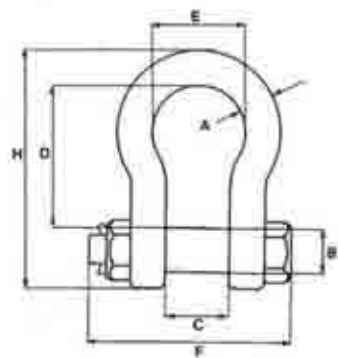

On-Site Service



Raft Boat Fabrication

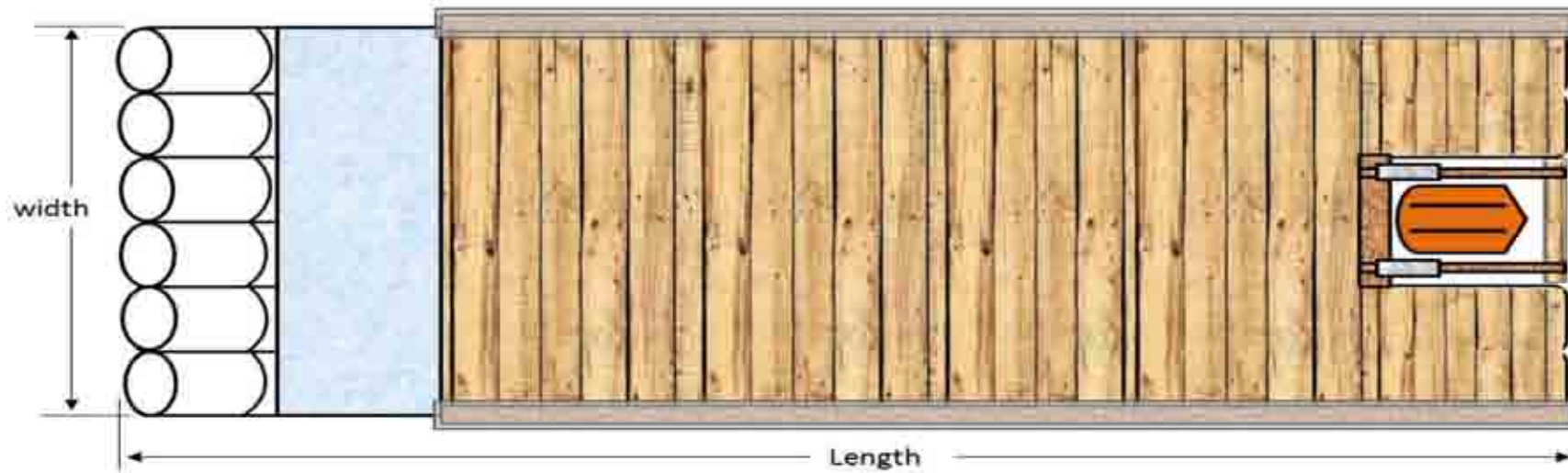

- Superior expert fusion technique & PE-100 material
- Professional design for durability, factory fabricated stanchions

Raft Models	RB-0950S	RB-0950D	RB-1150S	RB-1150D
Length (LOA)	9.5 M	9.5 M	11.5M	11.5 M
Beam (BOA)	225 cm	225 cm	245 cm	245 cm
Pipe structure: HDPE-100	355mm	355mm	400mm	400mm
Pipes layer	Single	Double	Single	Double
Weight without engine	1970 kg	2660 kg	2740 kg	3840 kg
Max. horse power	115 hp	115 hp	140 hp	140 hp
Designed horse power	60 hp up	85 hp up	85 hp up	115 hp up
Max. load	1000 kg	3000kg	2100 kg	5600 kg
Wood decking	Yes	Yes	Yes	Yes

Raft Boat Fabrication



Work Boat

These open work boats offers great design, quality build, unique flexibility, and low maintenance. Toford's rigid buoyancy boat have rigid pipes filled with polystyrene and it combined with V-shaped hull, this design makes a virtually unsinkable boat with unique stability and excellent seaworthiness.

Equipment :

- 4 pcs mooring cleats
- Stowage space with hatch
- Manual bilge pump
- Anchor and rope
- Fuel tank
- Battery compartment & Electric starting system



Models	WB-0450	WB-0560	WB-0760
Length (LOA)	450 cm	560 cm	760 cm
Beam (BOA)	220 cm	230 cm	270 cm
Pipe structure: HDPE-100	Yes	Yes	Yes
Displacement	500 kgs	700 kg	1090 kg
Max. horse power	80 hp	100 hp	200 hp
Designed horse power	50 hp	80 hp up	150 hp up
Max. load	800 kgs	1000 kg	2250 kg
V-bottom	Yes	Yes	Yes

Water Light & Signal Light

Feature	<ul style="list-style-type: none"> + High resistance to UV rays and wear from acid/alkaline. + Adopts PC protective tubing. + Power : DC12V/24V or AC110V/220V + 100% waterproof. IP68
Application	Vessels, Fishing vessels, Indoors illumination, For gathering fishes underwater, Fishing purposes.



Feature	<ul style="list-style-type: none"> + Automatic one color twinkle/rotation of signal lamp. + Power : DC 6V(UM-2 x 4) + Working time : Up to 360 hours + 100% waterproof. IP68
Application	Fishing operations, marine engineering, warning of road works, police road stops, mountain climbing, diving.



Feature	<ul style="list-style-type: none"> + Battery : 4.8V 5000mA High grade NiMH + Solar panels : Silicon · 8V250mA 2.0W (internal) + Working time : Storage battery energy (flashing) at full charge 200 hours + 100% waterproof. IP68
Application	Fishing operations, marine engineering, warning of marine, fishing aquaculture.



Dead Fish Collector System

Toford supplies complete automatic solutions for collection of dead fish. The benefits you get from using automatic dead fish collector systems are many, such as:

- Fast, simple and efficient removal of dead fish
- Reduces risk of net attacks from predators, like seals, sharks etc.
- Reduction of escapes through netting holes
- Improvement of safety, hygiene and farming environment
- Reduction of feed waste and drug use
- Better control of feed and fish diet
- Final production increase
- Prolonged lifespan of fish farming sites

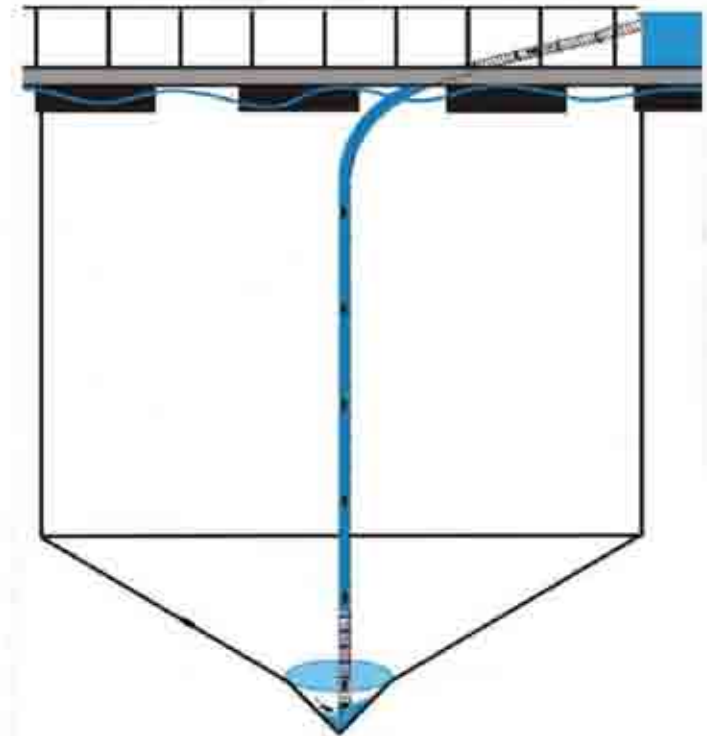

Easyfloat



Can be assembled and built for floating dock / pontoon / platform as you wish
Set-in nuts on the Easyfloat for fixing the deck and any object easily & saving cost



Deployed Cages

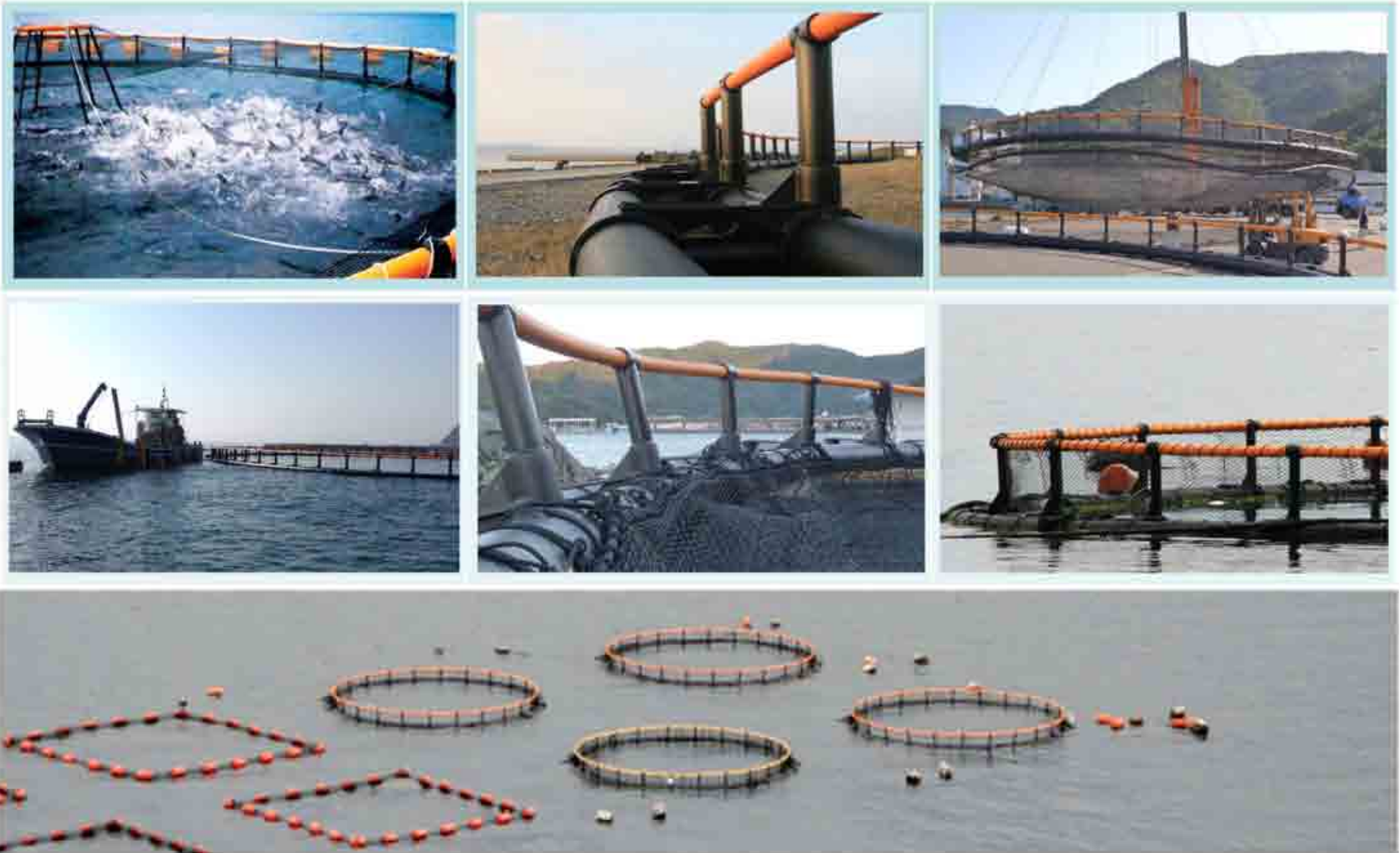

Track Record | 630 and Counting

Toford has produced plastic cages since 1995 – more than 600 fish cages have been delivered globally.

Location	Total Qty of cages
TAIWAN	120 sets
JAPAN - Osaka / Kyusyu / Nakasaki	250 sets
INDONESIA - Jarkata	50 sets
PHILIPPINES - General Santos, Sual city	140 sets
RUSSIA - Sakhalin	6 sets
MEXICO	4 sets
MAINLAND CHINA - Fukien	60 sets



Destructive Test & Twist Test



Strong fusion



Twist test



Certifications

ISO 9001



TOFORD BEVATTNINGSTEKNIK AB for Scandinavian

Helsingborgsvägen 578, 262 96 ÄNGELHOLM, SWEDEN

TEL: 0046 - 431 222 50

torle@bevattningsteknik.se

www.bevattningsteknik.se